



## VTU : LED VAPOR TIGHT UTILITY

### DESCRIPTION

The EiKO VTU fixtures are designed for durability and flexibility in multi-functional indoor and outdoor market segments. The pivoting design allows for use in a wide range of applications with either vertical or horizontal positioning. Die cast and powder coated for corrosion resistance, with silicone seals to ensure vapor proof performance in wet locations.

### FEATURES

- Die-cast aluminum construction
- Adjustable for wall or ceiling mount
- Frosted glass lens minimizes glare

### LISTINGS

- UL Listed for wet locations
- IP65 Rated
- ENERGY STAR® Rated

### PERFORMANCE

- Rated lifetime: L70 56,000 hours per IES TM-21-11
- 3000K, 4000K, 5000K CCT
- CRI: 80+

### ELECTRICAL

- Input voltage: 120-277V; 50/60Hz
- Power Factor: >.9
- THD: <20%
- 2kV surge protection

### THERMAL

- -22°F up to 122°F (-30°C up to 50°C) operating temperature

### CONSTRUCTION

- Die-cast aluminum construction
- Frosted glass lens
- Durable powder coated finish for corrosion resistance and maintenance free housing
- Silicone seals to ensure vapor-proof performance
- KOs are 1/2" trade size for conduit and photocontrols

### WARRANTY

- 5 year limited warranty; see eiko.com for warranty details

project name	type
catalog number	
comments	voltage
approved by	date



### APPLICATIONS

- Security lighting
- Entryways
- Perimeter lighting
- Industrial parks
- Loading docks
- Walkways
- Landscape
- Garages
- Utility Rooms



## ORDERING INFORMATION

EXAMPLE: VTU-20/20W/840-U-GY

Model	Package	CRI/CCT	Voltage	Finish
VTU : Vapor Tight Utility	<b>8/8W</b> - 800 lm; 8W <b>20/20W</b> - 2,000 lm; 20W	<b>830</b> - 80 CRI; 3000K <b>840</b> - 80 CRI; 4000K <b>850</b> - 80 CRI; 5000K	<b>U</b> - 120-277V	<b>GY</b> - Grey <i>(Consult EiKO for other color options based on MOQ requirements)</i>

## PERFORMANCE SUMMARY

Order Code	Item #	Watts	Nominal Lumens	CCT	CRI	Volts	ES
10744	VTU-8/8W/830-U-GY	8W	800	3000K	80+	120-277V	★
10745	VTU-8/8W/840-U-GY	8W	800	4000K	80+	120-277V	★
10746	VTU-8/8W/850-U-GY	8W	800	5000K	80+	120-277V	★
10650	VTU-20/20W/830-U-GY	20W	2,000	3000K	80+	120-277V	★
10651	VTU-20/20W/840-U-GY	20W	2,000	4000K	80+	120-277V	★
10652	VTU-20/20W/850-U-GY	20W	2,000	5000K	80+	120-277V	★

★ENERGY STAR® Rated

## DIMENSIONS

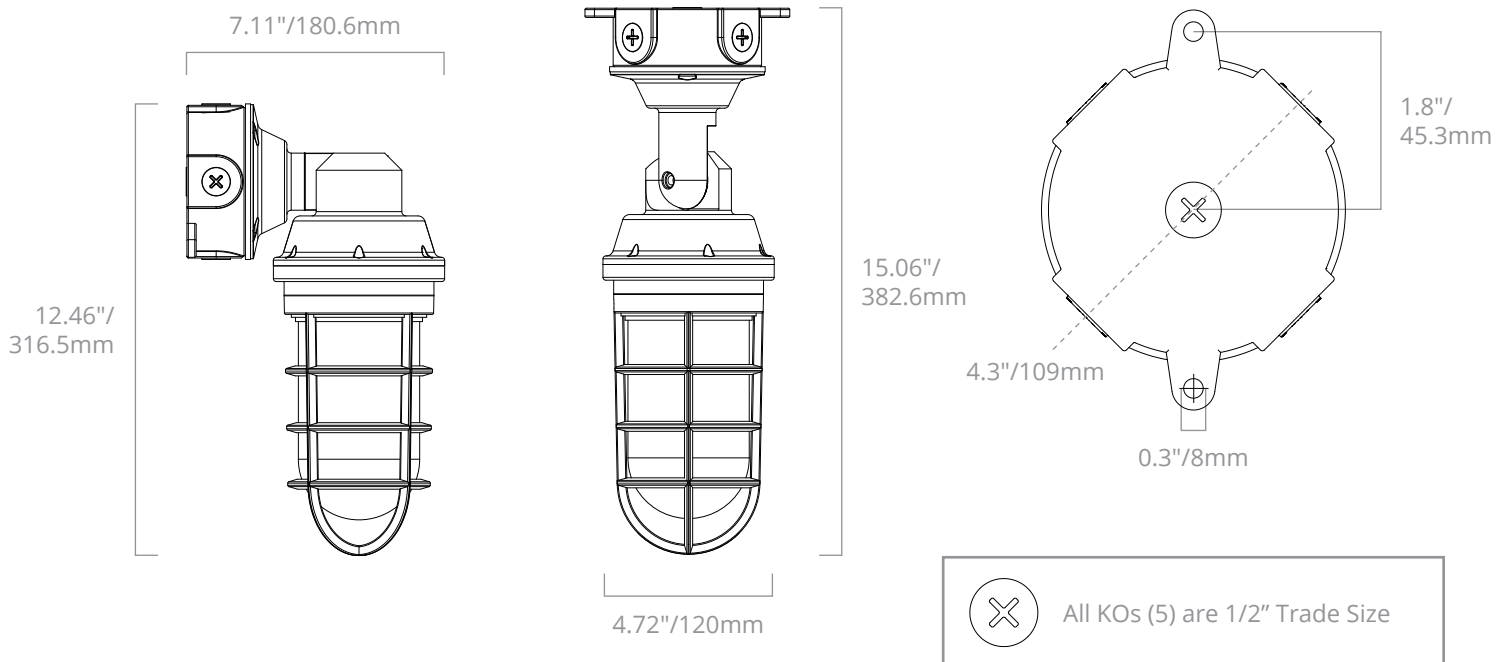

## AVAILABLE ACCESSORIES

Order Code	Item #	Description
09967	PC1-4136-U	Photocell, Stem Mount, Side Lens, 120-277V
09968	PC1-4236-U	Photocell, Stem Swivel Mount, Side Lens, 120-277V
09969	PC1-4736-U	Photocell, Stem Swivel Mount, Top Lens, 120-277V

VTU-20/20W/830-U-xx (Ceiling Mount)

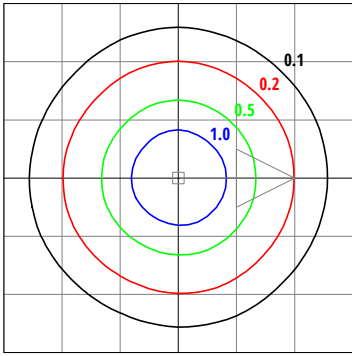

Scale is 10'; mounting height 10'

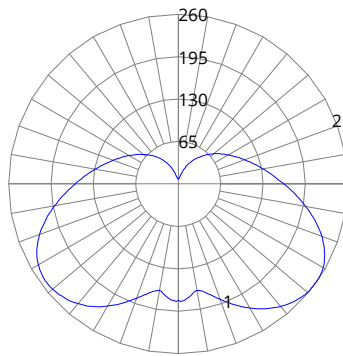

VTU-20/20W/830-U-xx (Wall Mount)

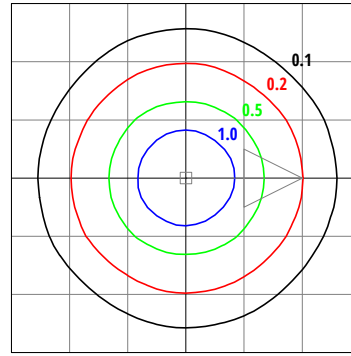

Scale is 10'; mounting height 10'

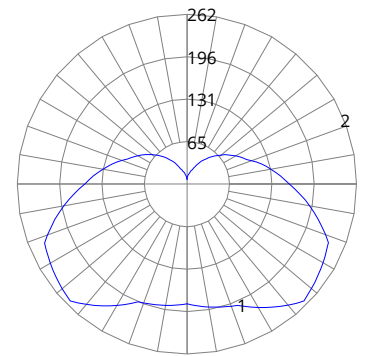

VTU-20/20W/840-U-xx (Ceiling Mount)

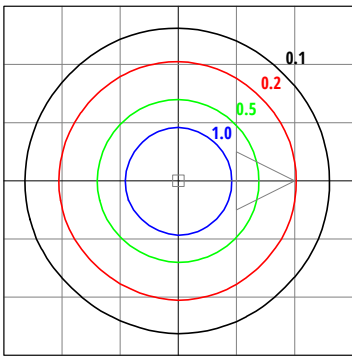

Scale is 10'; mounting height 10'

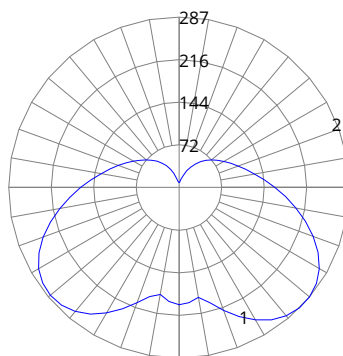

VTU-20/20W/840-U-xx (Wall Mount)

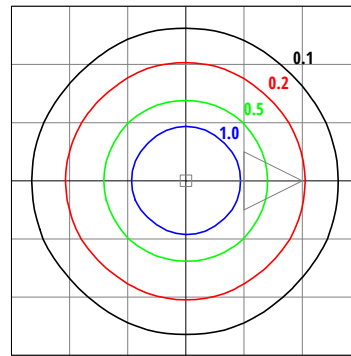

Scale is 10'; mounting height 10'

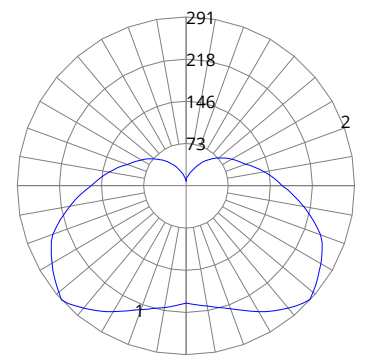

VTU-20/20W/850-U-xx (Ceiling Mount)

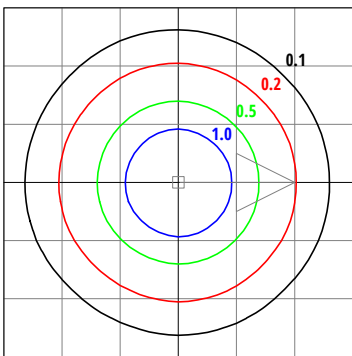

Scale is 10'; mounting height 10'

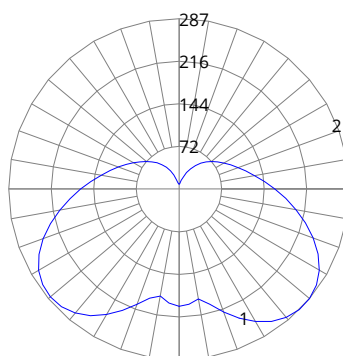

VTU-20/20W/850-U-xx (Wall Mount)

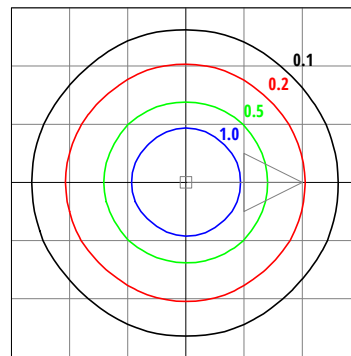

Scale is 10'; mounting height 10'

